

stair nosings

PVC profiles **skirtings** & trims



made in
the **UK**

wiseup@
www.floorwise.co.uk

Aluminium stair nosings

premium quality

Like all products bearing the **Floorwise** brand name, our stair nosings, PVC profiles, skirtings & trims are manufactured to the **highest quality standards**, made to deliver long lasting **performance**.

- page **3** **Aluminium stair nosings** – standard & heavy duty
- page **4-5** **Q-Range aluminium & uPVC stair nosings**
- page **6** **Stair nosing colour chart**
- page **7** **Stair edge trims & angles**
- page **8** **PVC skirtings**
- page **9** **PVC cove formers & capping strips**
- page **10** **Floormitre cap & cove system**
- page **11** **Flexible bevel strips, expansion joints, ramp & floor trims**
- page **12** **Curvable PVC floor trims**
- page **13** **PVC colour chart**
- page **14** **Entrance matting**
- page **15** **Floorwise distribution network**

wise up to floorwise
quality & value guaranteed

specialist measuring service

free stair nosing & entrance matting **measures**



saves **time**



saves **waste**



saves **money**

Book a FREE Stair Nosing or Entrance Matting measure today with Floorwise. Call today on **01509 673974** to book an appointment.

Standard gauge

Standard gauge aluminium stair nosings best suited for floorcoverings with a thickness of 2mm–3.5mm.

- **Stock lengths:** 2.44m, 2.75m and 3.2m
- **Pre-packed** (secret fixing): 20 lengths x 1.22m
- Also available **cut to size, drilled & undrilled**

○ Brightened Finish

○ Super Chrome Finish

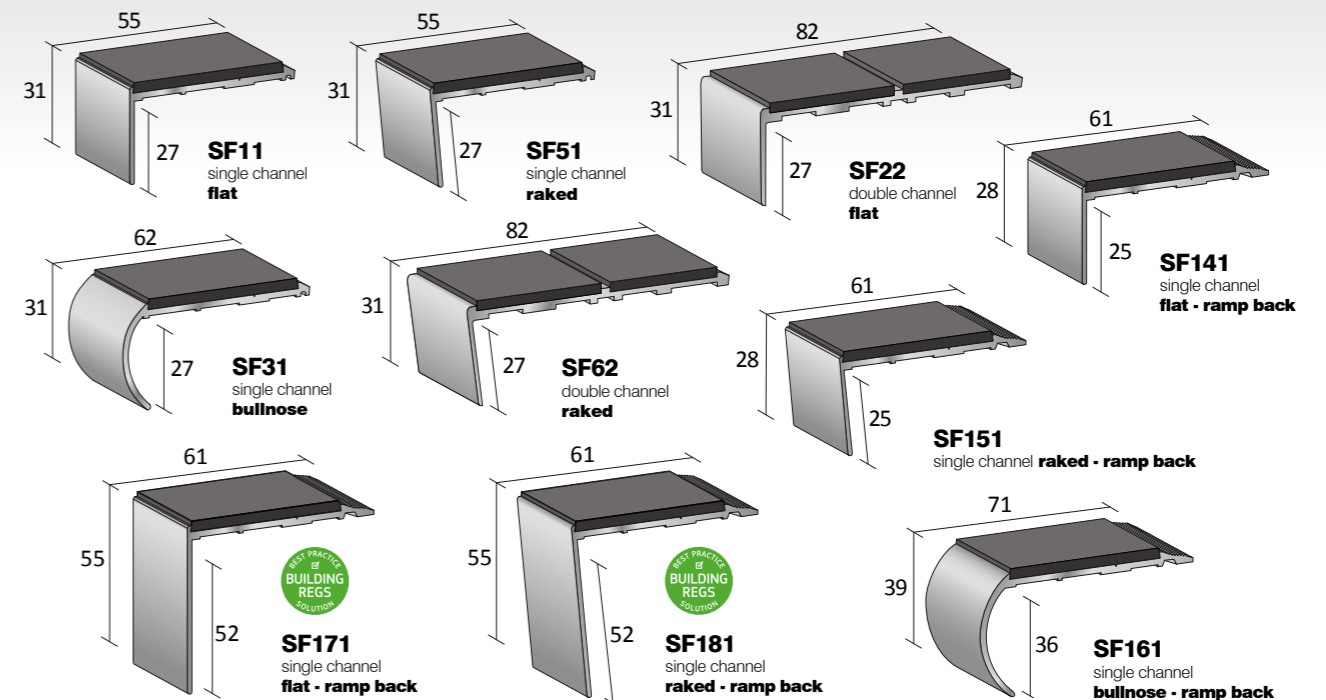

Drawings not to scale.

Heavy duty gauge

Heavy duty gauge aluminium stair nosings best suited for floorcoverings with a thickness of 4mm–7mm.

- **Stock lengths:** 2.44m, 2.75m and 3.2m
- **Pre-packed** (secret fixing): 20 lengths x 1.22m
- Also available **cut to size, drilled & undrilled**

○ Brightened Finish

○ Super Chrome Finish

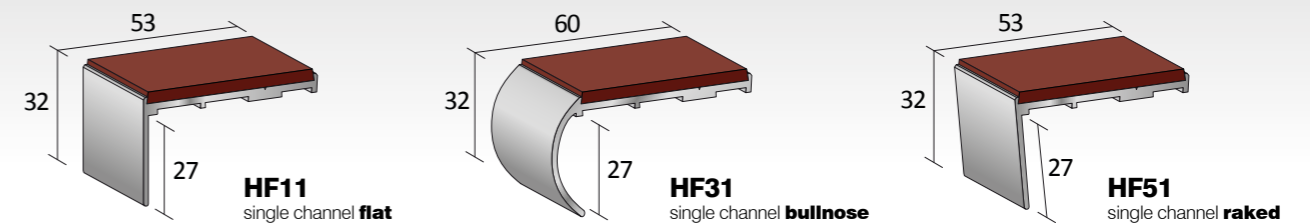

Super grip

A slip resistant and hard wearing stair nosing tread material

- Available on all Floorwise Stair Nosings (not available on Q-Range).
- Extremely low slip potential in dry and wet conditions. Fully laboratory tested.
- Suitable for industrial, public and commercial environments.

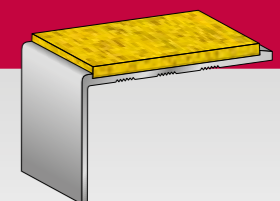

Q-Range aluminium & uPVC stair nosings

Q-Range aluminium & uPVC stair nosings

Q-Range: the complete stair nosing solution

Heavy Duty gauge stair nosings best suited for floorcoverings with a thickness of 4mm–7mm.

All Q-Range stair nosings (except bullnose) offer a Building Regulations best practice solution in uPVC or when specified with polar grey tread material.

NOTE: There should be 30 points of difference in the LRV value between the floor covering and the stair nosing.



- **Stock lengths:** 2.44m, 2.75m and 3.2m
- Also available **cut to size, drilled & undrilled**

● Satin anodised Aluminium

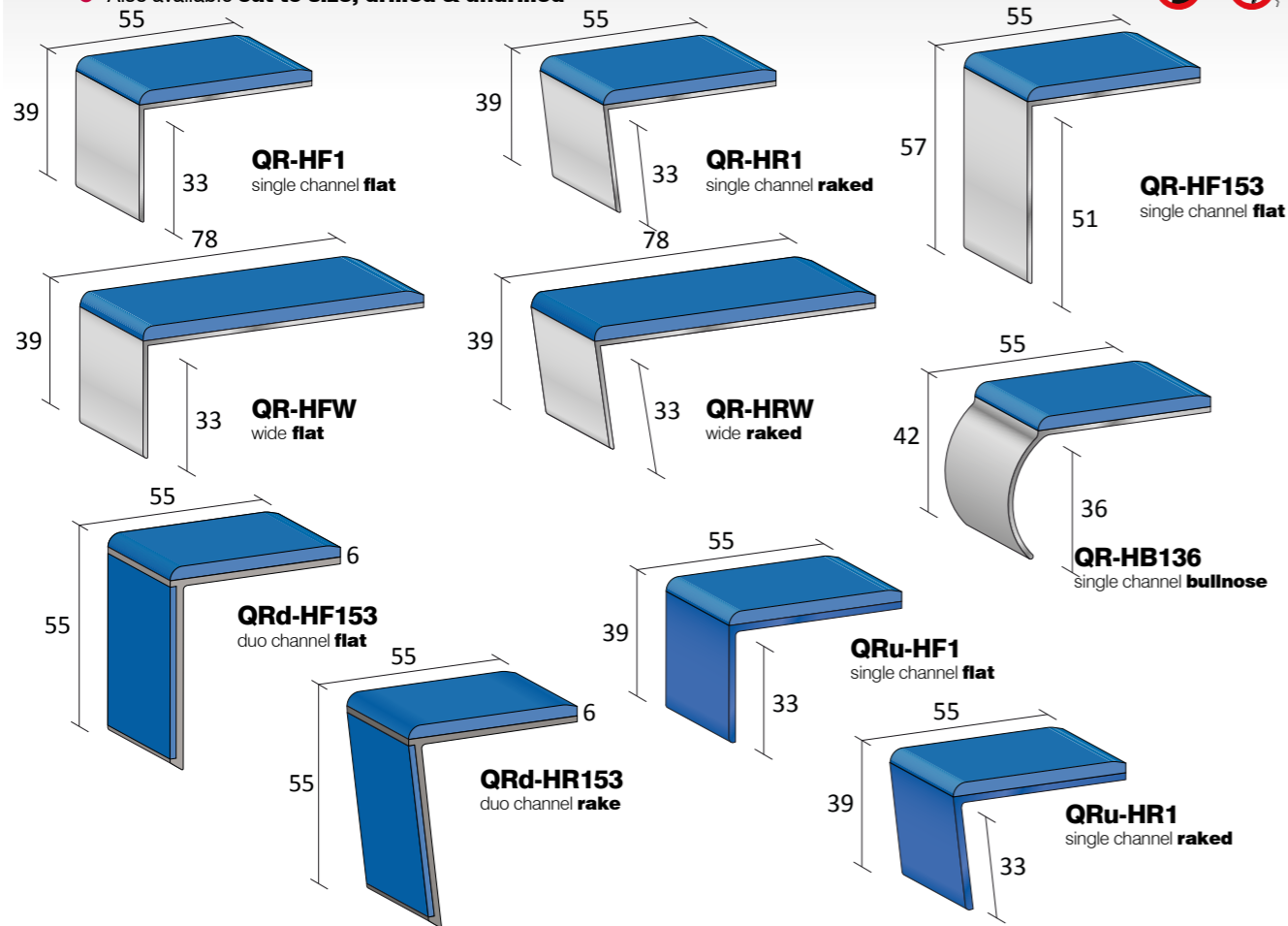

See page 12/13 for complete colour information.



specialist measuring service

free stair nosing & entrance matting measures

Book a FREE Stair Nosing or Entrance Matting measure today with Floorwise. Call today on **01509 673974** to book an appointment.

Drawings not to scale.

Q-Range: the complete stair nosing solution

Slenderline gauge stair nosings best suited for floorcoverings with a thickness of 0mm–3.5mm.

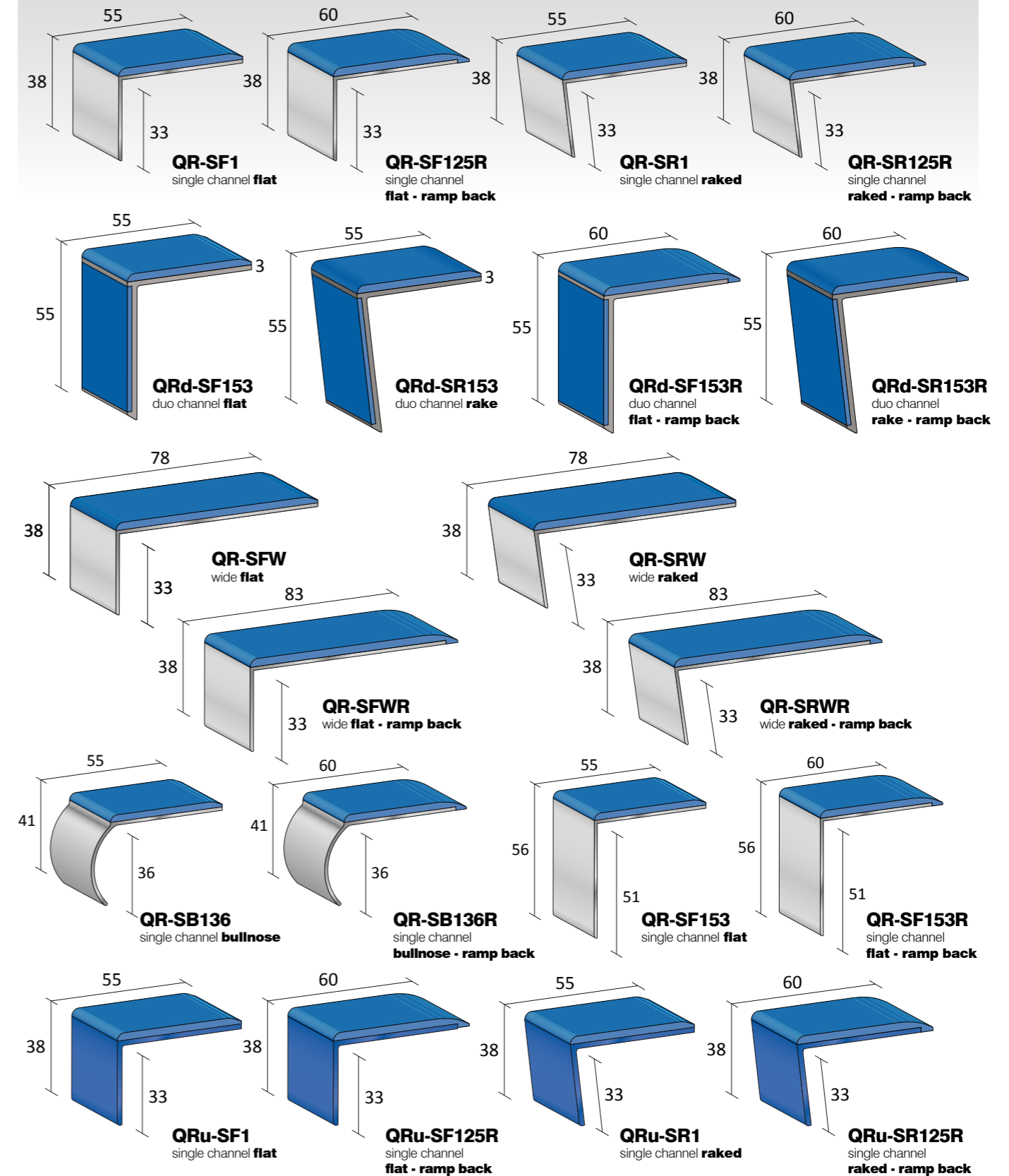

Aluminium & PVCu stair edge trims & angles

Pre-formed universal angles for finishing step sides on open string staircases.

- **Universal tabs** are included with package to cover all heights.
- **Pre-formed:** 83° or 90°, 360mm x 360mm, singles or boxed in 20s.
- **Stock lengths:** 2.75m complete with joints and tabs to make up on site.

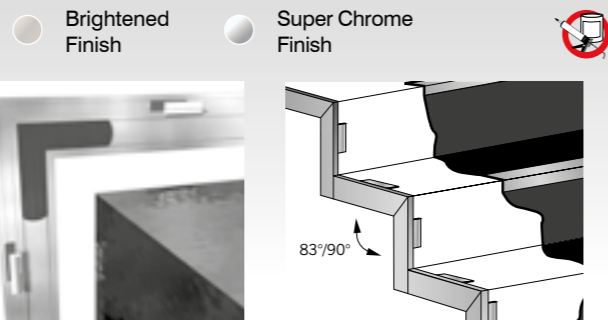

- | | |
|--|---|
| A610
Aluminium 83° pre-formed Angles | P610
PVCu 83° pre-formed Angles |
| A620
Aluminium 90° pre-formed Angles | P620
PVCu 90° pre-formed Angles |
| A600
Aluminium stock length 2.75m | P600
PVCu stock length 2.75m |

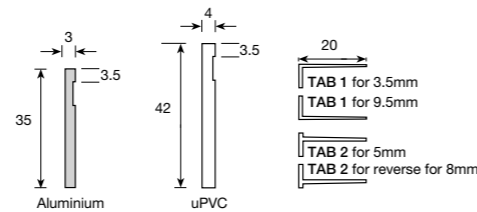

Stair nosing fabrications

Special shapes available - bespoke Stair Nosings factory fabricated to individual templates that have been measured and taken on-site. Contact your local Floorwise distributor for more details.

Mitred stair nosings

Most Stair Nosings can be mitred to suit any angle. They can either be dry mitred, meaning just cut to fit or the Stair Nosing can be mitred and then welded together for extra safety.



Curved stair nosings

Curved Stair Nosings are fabricated from templates taken from steps on-site. Then factory made to template and delivered labelled and ready to trim and fit on-site.



Sampling, installation & cleaning

To ensure an exact match for your requirements, please ask your local Floorwise distributor for a sample box.



For information about installation and cleaning, please ask your local Floorwise distributor for our special leaflet.



Sit-on skirting

Easy to fit standard skirting finish for vinyl floors.

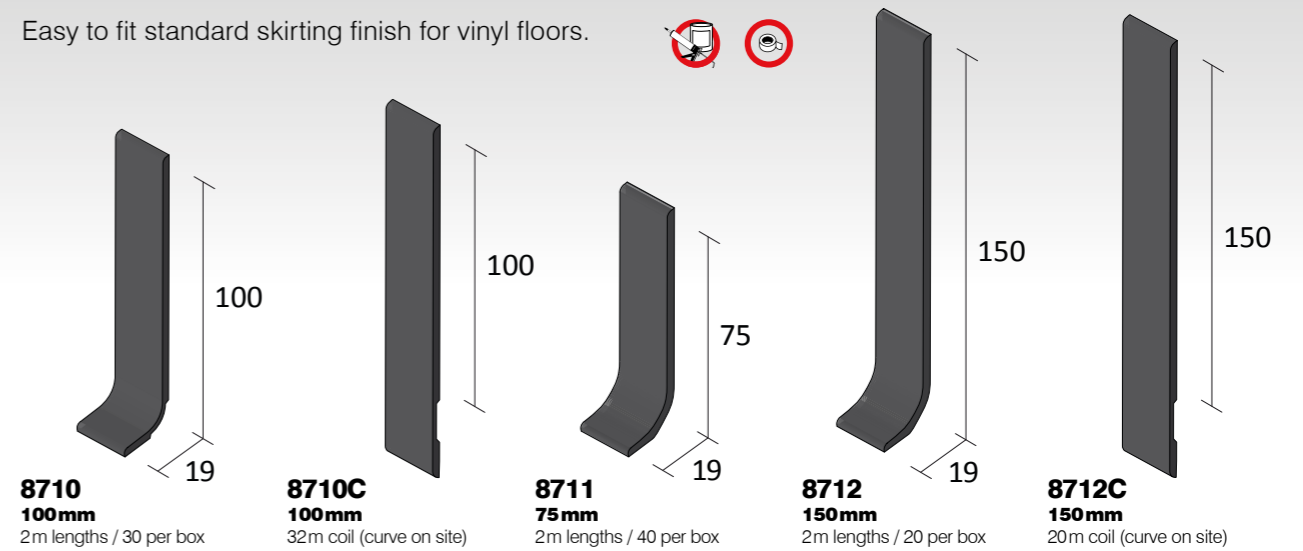

Set-in skirting

Skirtings with welded foot for seamless and hygienic finish with vinyl floors in hospitals, schools and wet areas (e.g. bathrooms).

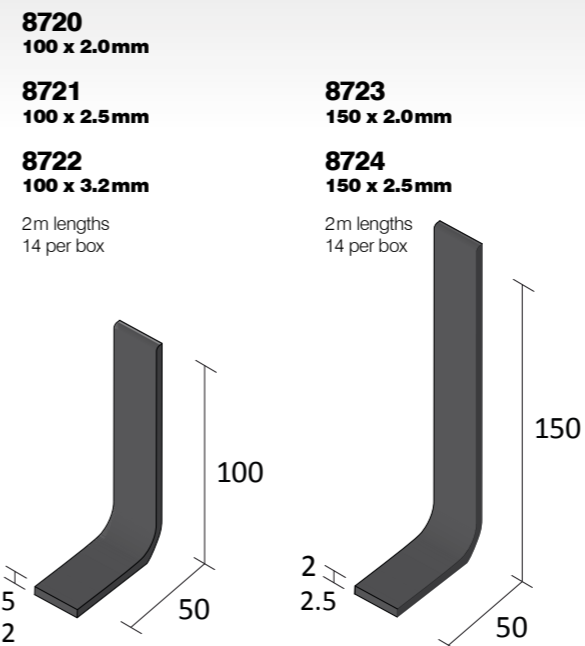

Flat skirting

Protective edge to wall and door bases. Use with vinyl floors or carpet tiles.

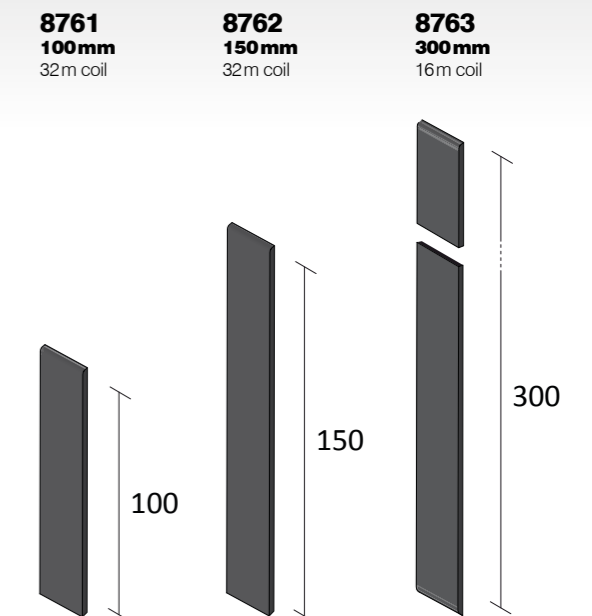

Drawings not to scale.

Capping strips

Finishing caps for floor coverings when material is formed up the wall base.



8740
40 x 4 mm

2m lengths
40 per box

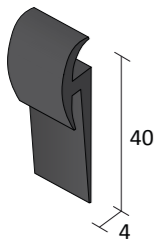

8741
45 x 4 mm

2m lengths
40 per box

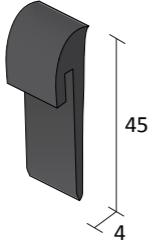

8742
40 x 6 mm

2m lengths
50 per box

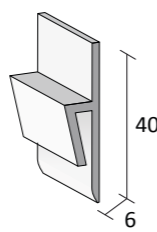

8744
38 x 4 mm

25m coils only
3 per box

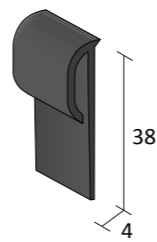

Cove formers

Preformed cove support for vinyl or linoleum flooring to curve up the wall base from the floor edge.



8731
20 x 20 mm

2m lengths
50 per box
(Black only)

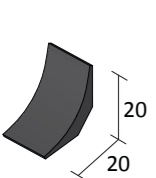

8730
32 x 32 mm

2m lengths
40 per box
(Black only)

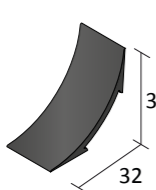

8732
35 x 35 mm

2m lengths
40 per box
(Black only)

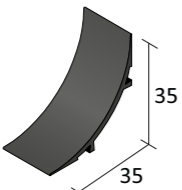

8733
42 x 42 mm

2m lengths
20 per box
(Black only)

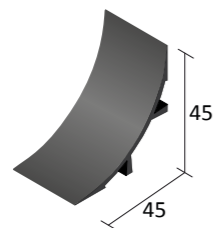

Combined cove former & capping strip

This combined, preformed cove former and capping strip is a valuable time saver on site.



- Offers better value than a separate cove former and capping strip.
- Neater finish.
- Easy to handle & easy to fit.
- Flexible cap to accommodate the floor covering.

8743
100 x 32 mm

2m lengths / 20 per box

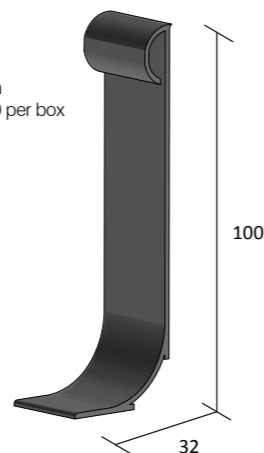

Drawings not to scale.

Internal & external floormitres

Designed to make the fitting of vinyl around corners easier, quicker and smoother.

This unique* flexible cove moulding creates a perfect uniform finish every time.

The preformed seamless Floormitre can be used with capping or diminishing strip at either 100 or 150 mm construction industry standard heights.

- Eliminates creases and kinks
- Promotes uniformity
- Reduces fitting times

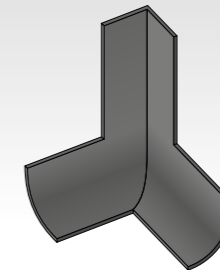

CCFM1
Internal Floormitre

50 per box

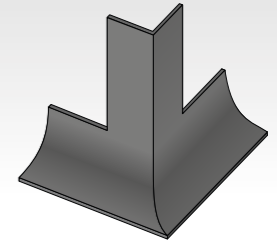

CCFM2
External Floormitre

50 per box

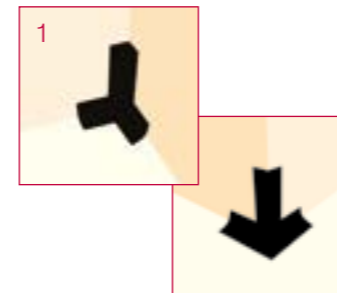

Install the preformed seamless Internal and External Floormitres.

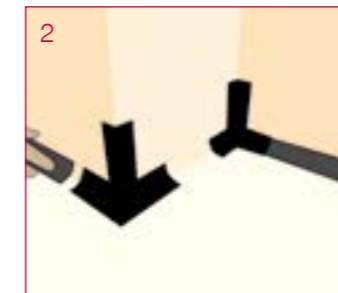

Install Cove Former to the Floormitres.

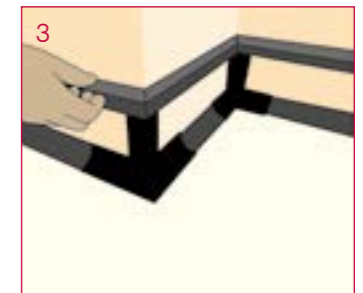

Install Capping or Diminishing Strip overlapping the Floormitres at the external and internal points.

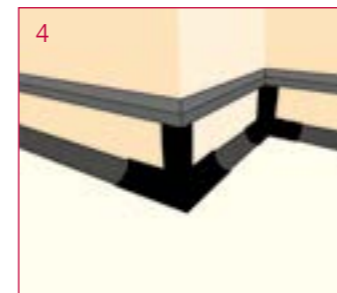

Prepared Floormitres are ready for the installation of vinyl.

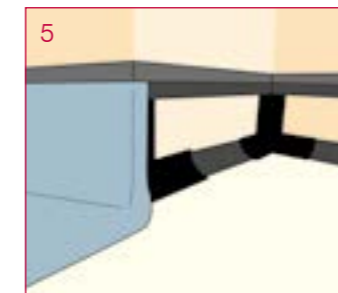

Complete vinyl with smooth radius and support for the external and internal corners.

NOTE: Vinyl can be wrapped as above or installed by the conventional method.

Use with:
Capping Strip & Cove Former

8740

8732

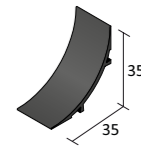
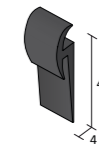

See page 12/13 for complete colour information.



Drawings not to scale.

Flexible bevels, ramps, profiles & joints

Curvable PVC floor trims

Bevel strips & ramp edges

Flexible finishing strips and ramps for floorcovering edges. Can be easily curved on site.

8751
25 x 2.0mm

8754
33 x 4.5mm

2m lengths
50 per box

8752
25 x 2.5mm

8755
38 x 6.0mm

2m lengths
50 per box

8753
25 x 3.2mm

25m coils
5 per box

Flexible flooring profiles

Finishing profiles for joints between floor coverings. Can be easily curved on site.

8770 Dual Edge
35 x 5mm/9mm

2m lengths
25 per box

8772 Ramp Edge
40 x 5mm

2m lengths
25 per box

Expansion joints

A solution to join vinyl floors. They are welded to the adjoining floorcovering using weld rod.

QCJ50
50 x 2.5mm

15m coils
3 per box

QCJ75
75 x 2.5mm

15m coils
2 per box

See page 12/13 for complete colour information.



Curvable floor trim system

The Curvable floor trim system is a two-piece product suitable for use in all commercial and public situations (including hospitals and schools). It can now fit across an even greater range of height differences at floorcovering joints, due to the redesigned clip-in top profiles which are securely accepted into the base sections. This system can now form a neat, safe and durable junction between practically any variation of different floorcoverings and uPVC bases can also be curved on-site.

- Curvable systems offer **self-levelling solution**
- Now available in **24 colours**
- **Multiple height** combinations
- A matt, **modern finish**
- **Greater durability** in commercial applications

	Top Profile Reference			
	8775	8780	8785	8790
87P2	18 14-16	17-18 13-15	17-18 15-17	n/a 15-19
87P4	14 11-13	14-15 10-12	14-15 12-14	n/a 14-16
87P1	10 8-9	10 7-9	12 10-12	n/a n/a
87P3	8-9 6-7	8-9 6-8	n/a 10-11	n/a n/a
87A1	8 5-7	8 5-6	n/a 8	n/a n/a
87A2	9-10 8-10	8-9 7-9	n/a 10-11	n/a n/a

Example: If a floor changes height at the junction from 15mm to 7mm a QVB4 base channel with a QTC42R profile would be ideal.

Self-levelling system

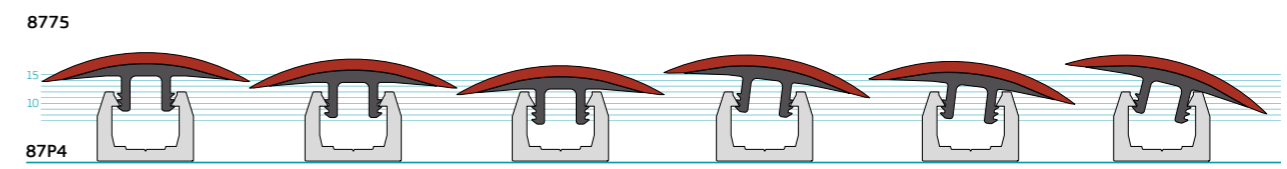

Ensure any asymmetric click is always tilted towards the side with the leg on the 8780 and 8785.

Note: some colours subject to minimum order quantities, please speak with your Floorwise distributor for details.

Drawings not to scale.

Stair nosings skirting trims colour chart

✓* Minimum quantities may apply

Code	Colour	LRV	Stair Nosings			Stair Edge Trims and Angles	Skirting	Coves and Capping Strips	Bevels and Ramps	Curvable Floor Trims
			Standard Tread	Super Grip (Not in Q-Range)	uPVC Channel					
CAR	Carbon	5		✓						
CLA	Claret	6	✓		✓	✓				✓*
BLK	Black	6	✓		✓	✓	✓	✓	✓	✓*
DBR	Dark Brown	9					✓	✓	✓*	
RUB	Ruby	9		✓						
RUS	Rustic	10	✓		✓	✓				✓*
PEA	Peat	10	✓		✓	✓				✓*
GRA	Granite	11	✓		✓	✓	✓			✓*
BLU	Dark Blue	11	✓		✓	✓				✓*
REG	Regency	11	✓		✓	✓	✓			✓*
SPR	Spruce	11	✓		✓	✓				✓*
POP	Poppy	13	✓							✓*
CHA	Charcoal	15					✓	✓	✓*	
FLI	Flint	15	✓		✓	✓				✓*
ROY	Royal Blue	16	✓							✓*
FAW	Fawn	21	✓							✓*
AQA	Aqua	22		✓						
BOU	Boulder	25					✓			
LIG	Light Grey	26	✓		✓	✓				✓*
PLA	Platinum	27		✓						
CLG	Cloud Grey	26					✓	✓	✓	
JAD	Jade	30	✓							✓*
CAR	Caramel	31					✓	✓		
TAN	Tangerine	33	✓							✓*
SAN	Sand	41		✓						
HOR	Hornet	47		✓						
PLR	Polar Grey	49	✓		✓	✓	✓			✓*
IVO	Ivory	51	✓		✓	✓	✓			✓*
SKY	Sky	52	✓							✓*
LIM	Lime	53	✓							✓*
SUN	Sun	56	✓							✓*
YEL	Yellow	67	✓		✓	✓				✓*
PHO	Photoluminescent	69	✓							
WHT	White	81	✓		✓	✓	✓	✓	✓*	✓*

wise up to floorwise
quality & value guaranteed



national distributor network

- 1 Neil Smith Ltd**
Glasgow, G4 0TX
Tel: 0141 552 1141
sales@neilsmithltd.co.uk
- 2 Provincial Floorcoverings Ltd**
Belfast, BT15 3GU
Tel: 028 9075 3202
Fax: 028 9075 3901
salesbelfast@pfl.ie
- 3 Provincial Floorcoverings Ltd**
Dublin, D12 E540
Tel: 00353 (0)1 626 3913
Fax: 00353 (0)1 460 4669
salesdublin@pfl.ie
- 4 Provincial Floorcoverings Ltd**
Limerick, V94 W863
Tel: 00353 (0)61 227 100
Fax: 00353 (0)61 227 000
sales@pfl.ie
- 5 Lakes Flooring Supplies**
Kendal, LA9 5RR
Tel: 01539 726500
sales@pucflooring.co.uk
- 6 Preston Underlay Centre Ltd**
Preston, PR1 1PN
Tel: 01772 556345
sales@pucflooring.co.uk
- 7 Birch Distribution**
Leeds, LS10 1AG
Tel: 0113 244 4363
Fax: 0113 244 8665
l.sales@birchdistribution.co.uk
- 8 Birch Distribution**
Hull, HU7 0XD
Tel: 01482 826654
Fax: 01482 878693
h.sales@birchdistribution.co.uk
- 9 Hathaway Flooring**
Manchester, M17 1EB
Tel: 0161 872 8003
sales@hathawayflooring.com
- 10 Cornerstone Flooring**
Doncaster, DN3 3FE
Tel: 01302 835117
Fax: 01302 302542
cornerstonefloor@btconnect.com
- 11 Birch Distribution**
Sheffield, S9 5PH
Tel: 0114 243 1230
Fax: 0114 243 5118
s.sales@birchdistribution.co.uk
- 12 Woodall Brothers Ltd**
Shrewsbury, SY1 3JE
Tel: 01743 441584
Fax: 01743 441629
sales@woodallbrothers.co.uk
- 13 Floorwise D & J Ltd**
Southam, CV47 0DR
Tel: 01926 814922
Fax: 01926 817899
sales@fwdj.co.uk
- 14 Floorwise Wales**
Merthyr Tydfil, CF48 4TQ
Tel: 01685 374243
sales@floorwise-wales.com
- 15 BL Flooring Supplies Ltd**
Gloucester, GL2 5HY
Tel: 01452 223355
Fax: 01452 371284
info@blflooring.co.uk
- 16 BL Flooring Supplies Ltd**
Bristol, BS2 9SH
Tel: 0117 955 5454
Fax: 0117 955 2626
info@blflooring.co.uk
- 17 Salesmark West Ltd**
Amesbury, SP4 7LN
Tel: 01980 880933
mail@salesmark-west.co.uk
- 18 Salesmark**
Lancing, BN15 8UN
Tel: 01903 750522
Fax: 01903 851111
sales@salesmark-floorwise.co.uk
- 19 Fitwell Flooring Ltd**
Newton Abbot, TQ12 6TR
Tel: 01626 835935
sales@fitwell.co.uk
- 20 Fitwell Flooring Ltd**
Redruth, TR15 1SS
Tel: 01209 214344
sales@fitwell.co.uk
- 21 STS Flooring Distributors Ltd**
Cambridge, CB23 8UD
Tel: 0345 899 1000
sales@stsflooring.co.uk
- 22 STS Flooring Distributors Ltd**
Hemel Hempstead, HP2 7ER
Tel: 0345 899 1000
sales@stsflooring.co.uk
- 23 STS Flooring Distributors Ltd**
Basildon, Essex, SS14 3DW
Tel: 0345 899 1000
sales@stsflooring.co.uk
- 24 STS Flooring Distributors Ltd**
Croydon, Surrey, CR0 4WP
Tel: 0345 899 1000
sales@stsflooring.co.uk
- 25 STS Flooring Distributors Ltd**
Orpington, Kent, BR5 3SS
Tel: 0345 899 1000
sales@stsflooring.co.uk

head office:

Floorwise Group Ltd.
Floorwise House, 22 High Street
Kegworth, Derby, DE74 2DA, UK
Tel: +44 (0)1509 673974
Fax: +44 (0)1509 674841



Entrance matting

Q-MAT: THE KNIGHTSBRIDGE

12 mm & 17 mm

Q-MAT: THE WESTMINSTER

15 mm & 19 mm

Q-MAT: THE BELGRAVIA

12 mm, 17 mm & 22 mm

Q-MAT: THE MAYFAIR

17 mm & 22 mm

Q-TILE 50CM ENTRANCE MATTING TILE

10 mm

Q-CLICK 25CM ENTRANCE MATTING TILE

12 mm

specialist measuring service

free stair nosing & entrance matting measures

Book a FREE Stair Nosing or Entrance Matting measure today with Floorwise. Call today on **01509 673974** to book an appointment.

When it comes to flooring installation, **Floorwise** is the name for **quality** and **value!**

For **over 40 years** Floorwise has been the **number one choice** for flooring professionals.

Reliable service, through an exclusive network of distributors, and the consistent quality of our products has earned Floorwise an enviable reputation.

Floorwise strives to deliver excellence in innovation too, with a continuous development programme aimed at meeting the evolving needs of both consumers and installers alike.

for **sales** and **enquiries** contact:

it's time to get wise

about **flooring installation** with our other **market-leading** products:

adhesives + screeds



gripper

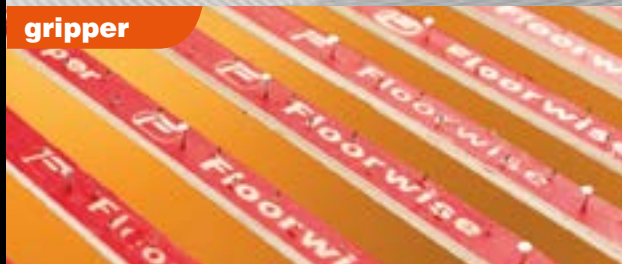

profiles



stair nosings, PVC skirting + trims



underlay



tools



find us on  @floorwisehq or visit us at www.floorwise.co.uk

© Floorwise Group Ltd, 2022



wiseup@
www.floorwise.co.uk